



Kit contents

 Kit contents might vary depending on your computer model. You may have to purchase additional HP Z Turbo storage devices.

- M.2 module
- Heat sink and thermal interface material
- Adapter
- LED cable
- Installation instructions (this document)
- Warranty information

Before you begin

To view QuickSpecs and determine the compatibility of this product with your HP computer, see <http://www.hp.com/go/productbulletin>.

Preparing for installation

- 1** If you need help preparing the computer for this installation, consult the removal and replacement procedures at <http://www.hp.com/go/hardwarevideos>.
- 2** Power down the workstation, and then disconnect the power cord.
- 3** Power down all external devices, and then disconnect them from the computer.
- 4** Remove the access panel.

© Copyright 2022 HP Development Company, L.P.

The information contained herein is subject to change without notice. The only warranties for HP products and services are set forth in the express warranty statements accompanying such products and services. Nothing herein should be construed as constituting an additional warranty. HP shall not be liable for technical or editorial errors or omissions contained herein.

First Edition: November 2022



N30596-001

Printed in U.S.A.

Installation

- 1** Press the heat sink levers down and then in to release the hooks in the following order.

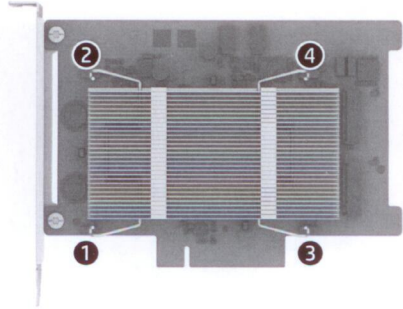

- 2** Remove the heat sink from the adapter.

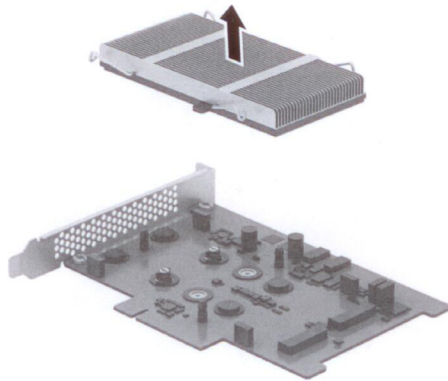

- 3** Remove the screw receptors from the M.2 slots on the adapter.

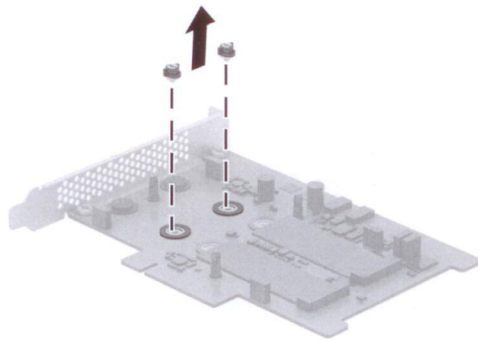

 The protective covering over the thermal pads is perforated. If you are installing a single module, remove half. If you are installing both modules or a second module, be sure that the entire covering is removed.

Installation
continued

4 Ensure that the standoffs and rubber bumpers are properly arranged.

- If you are installing a one-sided 2280 M.2 module, do not change the default arrangement.

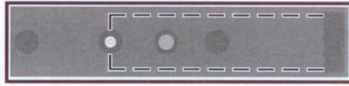

- If you are installing a one-sided 22110 M.2 module, move the outer rubber bumper to the standoff position. You will reinstall the standoff in the outer position.



- If you are installing a two-sided 2280 M.2 module, remove the inner rubber bumper.

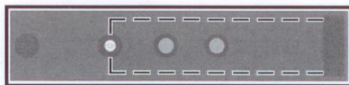

- If you are installing a two-sided 22110 M.2 module, remove both rubber bumpers. You will reinstall the standoff in the outer position.



5 Insert the standoff into the curve of the edge of the drive.

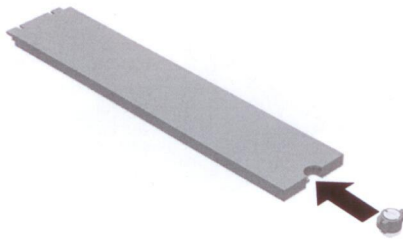

Installation
continued

 Install the first M.2 module into the M.2 slot closest to the top of the adapter.

6 Insert the M.2 module, label facing up, into the M.2 slot on the adapter at an angle **1** and then secure the standoff to the adapter **2**.

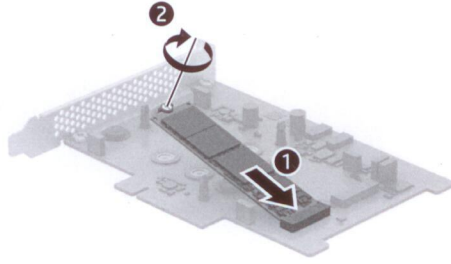

 Install the second M.2 module into the M.2 slot farthest from the top of the adapter.

7 Insert the optional second M.2 module, label facing up, into the M.2 slot on the adapter at an angle **1** and then secure the standoff to the adapter **2**.

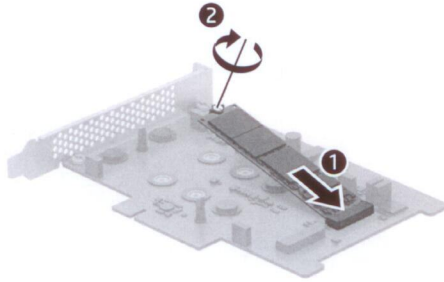

 If there is a protective covering over the thermal pads, remove it.

8 Place the heat sink on the adapter.

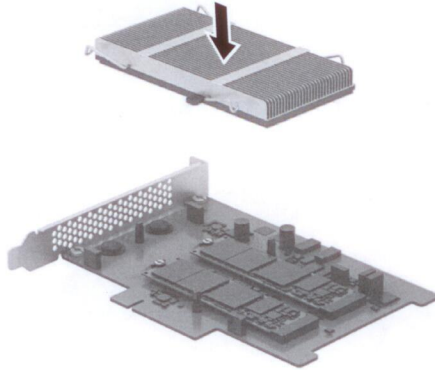

Installation
continued

- 9** Hold the middle of the heat sink down, and then press the hooks down in the following order.

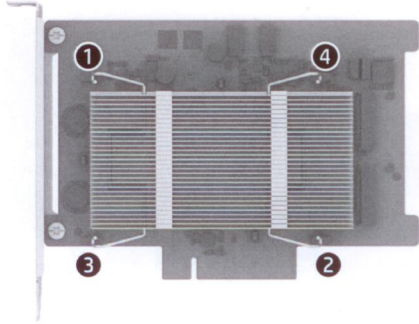

- 10** (HP Z8 only) Lift the PCIe retainer by the access point 1, rotate it up 2, and then remove it from the computer 3.

 Computer appearance might vary.

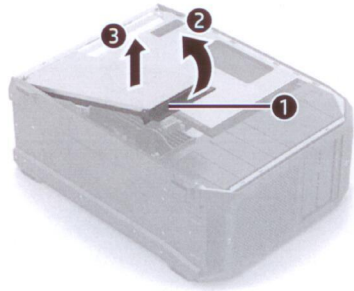

- 11** Remove the PCIe slot cover.

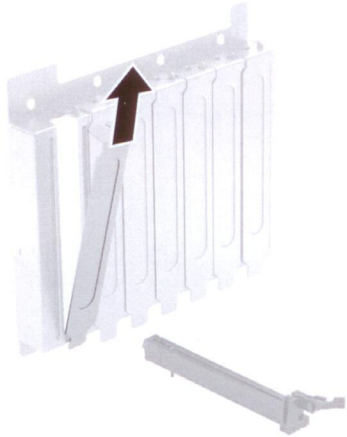

Installation
continued

- 12** Slide the adapter into the PCIe slot until it is fully seated. **Note:** If only one card is installed, connect the two-wire cable from the HDD_LED_OUT connector on the card to the HDD_LED_header on the system board. If multiple cards are installed, connect the two-wire cable from the HDD_LED_OUT header on one card to another card's HDD_LED_IN header to daisy-chain the signals together. The last card in the chain should connect the two-wire cable from the HDD_LED_OUT connector on the card to the HDD_LED header on the system board.

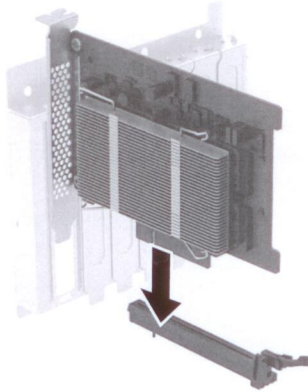

- 13** Insert the PCIe retainer into the computer **1**, and then lower it **2** into place.

 Computer appearance might vary.

On models other than Z8, relatch the PCI card bracket latch.

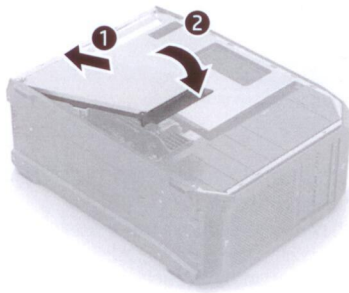

After the installation

- 1** Reinstall the access panel.
- 2** Reconnect external devices and power cord, and restore power to all external devices.



For regulatory, certification, and environmental information, including Restriction of Hazardous Substances (RoHS), scan the QR code, or go to www.hp.com/go/regulatory.