

▶ Best Practices Guide
Polycom SoundStructure and HDX Microphones



This document introduces HDX microphones and the best practices for using the HDX microphones with SoundStructure devices. In addition this document describes how to use the combination of SoundStructure devices, HDX codecs, and HDX microphones as well as how to use multiple SoundStructure devices when more than four HDX microphones are required.

Table of Contents

SoundStructure Devices	3
Connecting HDX Microphones	4
HDX Microphones	4
HDX Ceiling Microphones	4
HDX Table Microphones	6
Cable Length Requirement	7
Best Practices when Installing HDX Microphones and SoundStructure	7
Step 1 – Verify microphones operate and have the latest microphone firmware	7
Step 2 – Verify microphones operate when daisy chained	9
Step 3 – Check the channels page for valid signals levels	11
Step 4 – Install the microphones in final desired locations	12
Step 5 – Confirming and adjusting signal levels	12
Which HDX Microphone is Which?	13
SoundStructure and HDX and HDX Microphones	14
Maximum number of HDX microphones that can be used	14
HDX 8000 and SoundStructure	15
Multiple SoundStructure Units and HDX Microphones	15
Advanced Applications with HDX Microphones	17
Using Fewer than three microphone elements	17
Switching between Analog or Digital microphone inputs	19
Cable Summary	21
Cables available on the Polycom Price list	21
Custom cables	21
Unshielded Conference Link Cross over cable	21
Shielded Conference link Cross over cable	22

SoundStructure Devices

Up to 4 HDX microphones can be connected to each SoundStructure device, subject to the following constraints:

- Each HDX microphone requires three available analog inputs on the SoundStructure device
- HDX microphone cable and cable length requirements are met

This means that a SoundStructure C8 can support 2 full HDX microphones, a C12 can support 4 HDX microphones, a C16 can support 4 HDX microphones, and an SR12 can support up to 4 HDX microphones .

HDX microphones connect to the SoundStructure device over the Conference Link digital interface as described later in this document. When HDX microphones are used with SoundStructure devices, the SoundStructure device's analog inputs associated with the HDX microphone inputs can not be used at the same time as the digital inputs from the HDX microphones. For example, in the figure below two HDX table top microphones are connected to the SoundStructure C8. Because each HDX microphone is the equivalent of three analog microphones, even though the microphones are connected over the Conference Link connection, six of the SoundStructure device's input processing channels must be reserved for the HDX microphone inputs. The wiring page within SoundStructure Studio shows the six inputs (inputs 3 – 8) are being used by the HDX microphones.

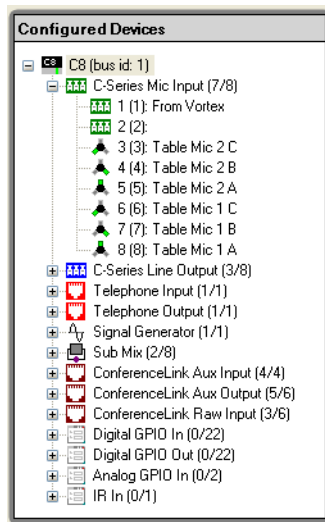

See the “Advanced Applications” section for information on how the analog inputs may be switched for operation for either HDX microphones or analog inputs via the `mic_source_type` SoundStructure API command.

When multiple SoundStructure devices are linked together via the OBAM link, then each SoundStructure device may have up to four HDX microphones connected to it, subject to the constraints described above. More information may be found in the “Multiple SoundStructure and HDX Microphones” section.

Connecting HDX Microphones

HDX Microphones are connected to SoundStructure via a Conference Link cross over cable and any connection from SoundStructure to a microphone and from one microphone to the next microphone must be a Conference Link cross over cable. As described later in this document, the best practice is to connect the first HDX microphone to the SoundStructure device's right rear Conference Link port. The pin out of the Cross over cable is described in the "Cable Pin Out" section.

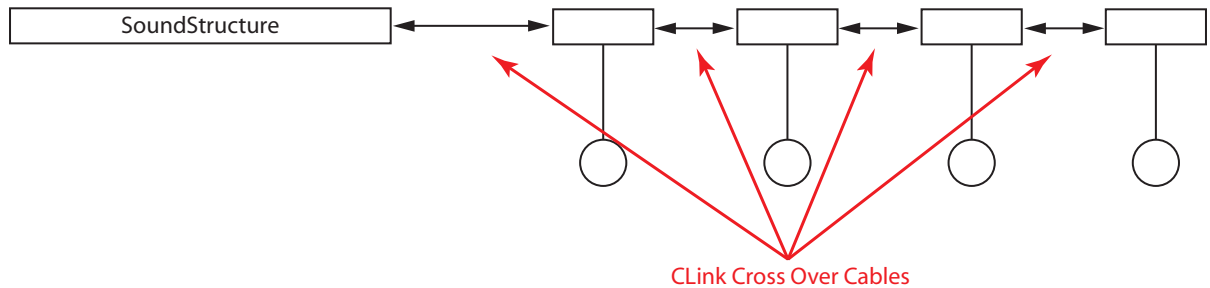

HDX Microphones

There are two main styles of HDX microphones: table top microphones and ceiling microphones. Both styles of microphones have three microphone elements that pick up audio in a 360-degree pattern around the microphone.

Within SoundStructure Studio, the three microphone elements in each microphone are labeled as elements A, B, and C with the orientation shown in the figure below.

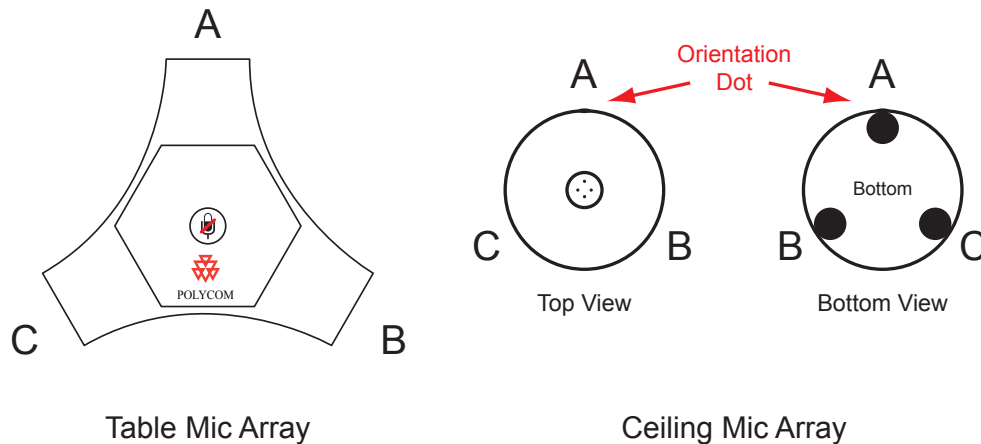

HDX Ceiling Microphones

There are two main SKUs for HDX ceiling microphones and each of these SKUs comes in either black (part number ends in -001) or white (part number ends in -002) for a total of four different combinations.

The two main SKUs for the HDX ceiling microphones in black are listed below and both microphone SKU kits come with the ceiling microphone ball, electronics box, and cable to connect the ball to the electronics box. The kits differ in the cables that are supplied to connect to a SoundStructure device.

2215-23809-001	2215-23810-001
full ceiling microphone	extension ceiling microphone
50ft shielded conference link cross over cable	25ft shielded conference link cross over cable
HDX microphone and electronics	HDX microphone and electronics
RJ45 wall plate	-
10ft conference link straight through cable	-

The SKU 2215-23809-001 (full ceiling microphone) would be appropriate to use for the first microphone in a multi-microphone system and includes a 50ft cable. The SKU 2215-23810-001 (extension ceiling microphone) is an extension microphone that includes a 25ft cable and is appropriate to use for all subsequent HDX microphones after the first microphone. Both the 25ft and 50ft cables are plenum-rated shielded CAT5e cables.

The SKU 2215-23809-001 (full ceiling microphone) also includes a wall plate and a 10ft straight-through Conference Link cable that can be used to connect from the device to the wall plate, and then from the wall plate the system can connect to the first microphone as shown in the following application. In the figure below there is still a single cross over cable from the SoundStructure to the first HDX microphone because the 10ft straight-through cable acts as a 10ft extension of the 50ft cross over cable, and because the 10ft cable is straight through, the 60ft resulting length still contains a single crossover.

SoundStructure to the first HDX microphone because the 10ft straight-through cable acts as a 10ft extension of the 50ft cross over cable, and because the 10ft cable is straight through, the 60ft resulting length still contains a single crossover.

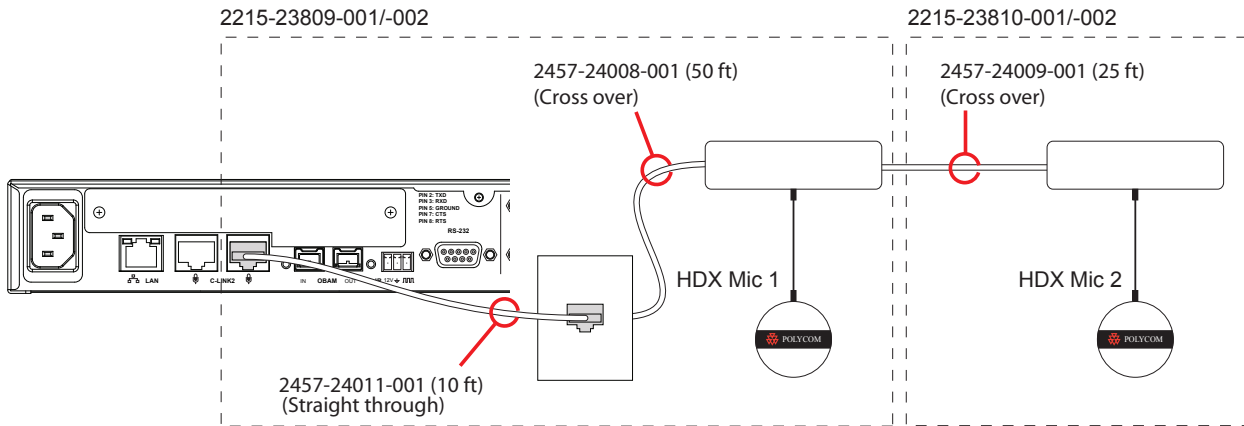

Note: The 10ft cable (2457-24011-001) is a Conference Link straight through cable. If you use this cable to connect from the SoundStructure to the microphone directly, the microphone will not be discovered. A Conference link cross-over cable must be used between the SoundStructure and the microphone.

Remember these kits differ primarily in the length of the Conference Link crossover cable supplied: 50ft vs. 25ft cable.

A typical installation that requires 4 HDX microphones would include one 2215-23809-001 and three 2215-23810-001 microphones. In addition, it is acceptable to order four 2215-23810-001 microphones if the first HDX microphone is less than 25ft away from the SoundStructure device.

Daisy-chaining two full HDX microphone kits with the 50ft cables would not be a valid installation option since the maximum length between the first and second microphone is only 25ft.

HDX Table Microphones

HDX table microphones may also be used with SoundStructure products. Due to the different connectors on the HDX table microphone cables (Walta connector) and the SoundStructure (RJ45 connector), a conversion dongle or custom cable must be used to connect HDX table microphones directly to a SoundStructure device. The following table summarizes two dongles that are available.

Dongle	Part Number
Walta Male to RJ45 Female	2457-25646-001
Walta Female to RJ45 Male	2457-23716-001

These dongles are shown in the following figure.

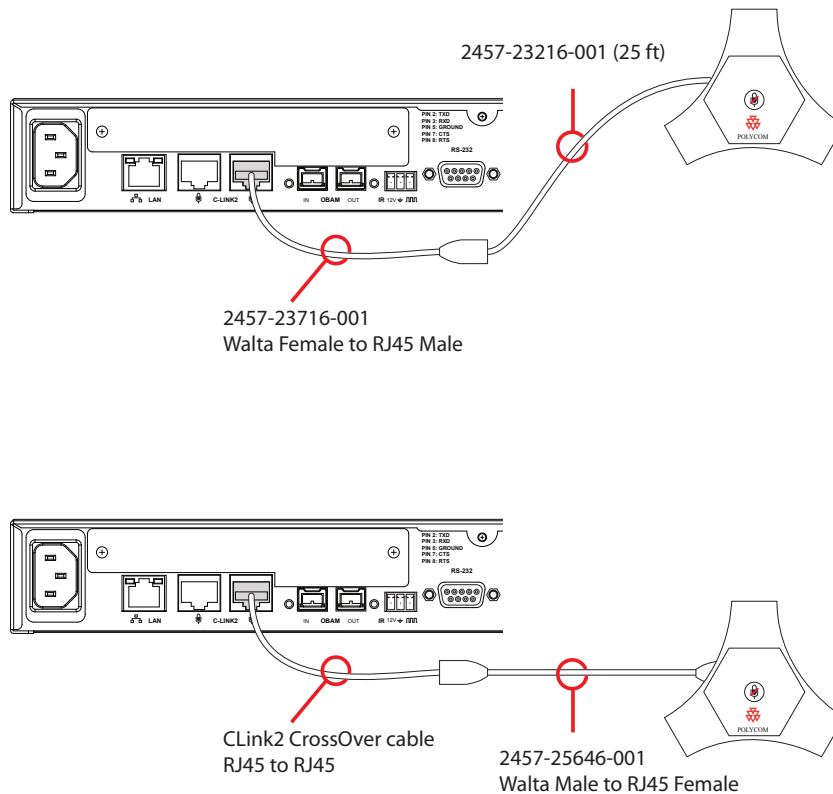

The HDX microphone mute button may be used to mute and unmute the microphones within SoundStructure. As described in the SoundStructure Design Guide, the virtual channel "Mics" must be defined and include all the signals to be muted when the HDX table microphone mute button is pressed.

Note: If the name "Mics" is not defined then nothing will be muted within SoundStructure when the mute button is pressed on the HDX table top microphones. "Mics" can refer to a single input, output, submix, or a group of virtual channels. By default, SoundStructure names the group of microphones "Mics".

Cable Length Requirement

Follow the recommended cable length requirements to ensure your microphone configurations match the following diagram. The first microphone can have up to 100ft of Conference Link cable and subsequent microphones can have no more than 25ft of cable.

Conference Link Connections with shielded cable for lengths > 25ft

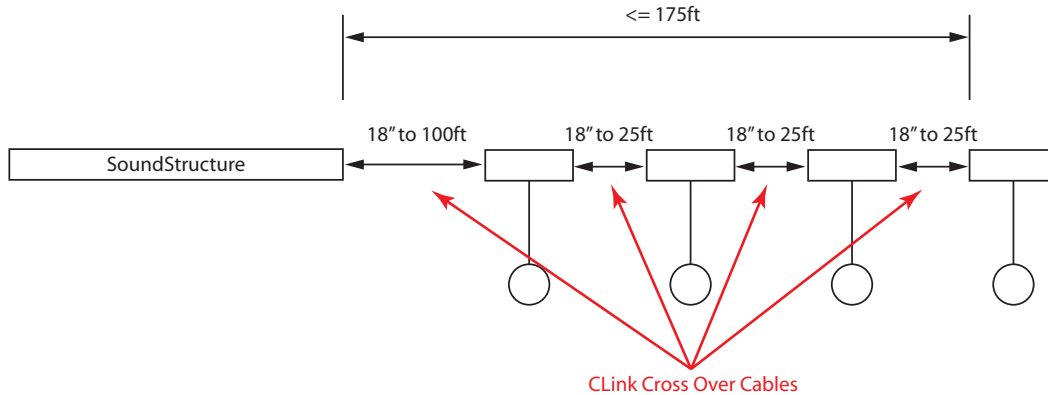

Cable lengths from the SoundStructure to the first microphone that are longer than 25ft should be shielded CAT5E cables.

Best Practices when Installing HDX Microphones and SoundStructure

Please follow the steps below to ensure your HDX microphones are installed properly and with a minimum amount of effort. Skipping any of the steps below may cause your installation to take longer than expected due to cable or microphone issues that would have been detected in one of the earlier steps.

Step 1 – Verify microphones operate and have the latest microphone firmware

Plug each microphone one at a time to SoundStructure via a known good cable to make sure the SoundStructure device detects the microphone and it operates properly. If there is an HDX video codec connected to SoundStructure over Clink, unplug the HDX Clink cable from the SoundStructure device for this step.

Once the HDX microphone is plugged in you may see the LED's flash orange as the firmware in the microphone is updated by the SoundStructure device. If the LED's on the microphones are continuously orange then that microphone must be returned with an RMA to Polycom and replaced with a microphone that is labeled Rev E or higher.

Note: If LED's on the microphone turn orange and continue to flicker orange or stay solid orange continuously the microphone must be replaced.

The diagrams below show how to connect the HDX microphones one at a time to SoundStructure.

Clink crossover cables
 18in 2457-23574-001
 25ft 2200-24008-001
 50ft 2200-24009-001

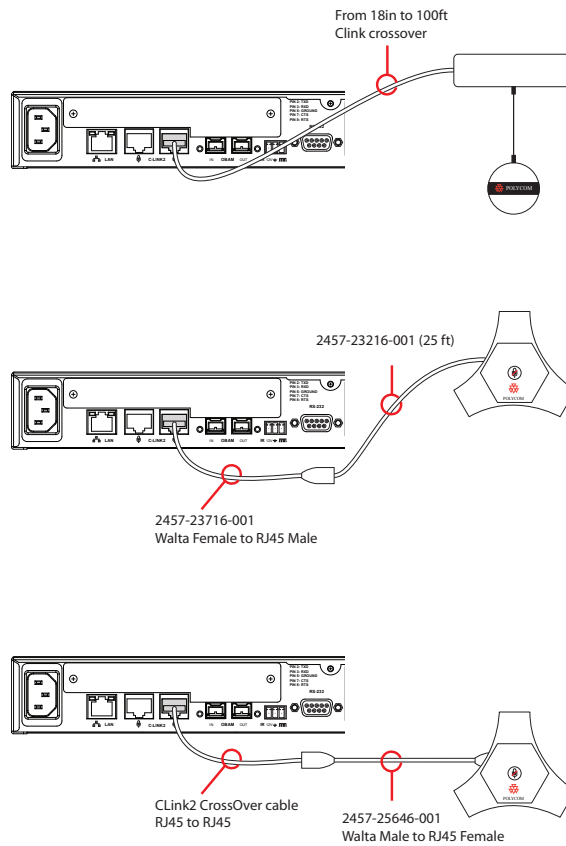

To see if the HDX microphone is discovered by the SoundStructure device check the wiring page. If a microphone has been discovered, it will be shown as discovered, as highlighted in the figure below. Please ensure the Poll Device Information control is checked – that ensures that SoundStructure Studio will continuously query the SoundStructure device to see how many microphones are connected. Otherwise the information is only updated when the wiring page is first navigated to.

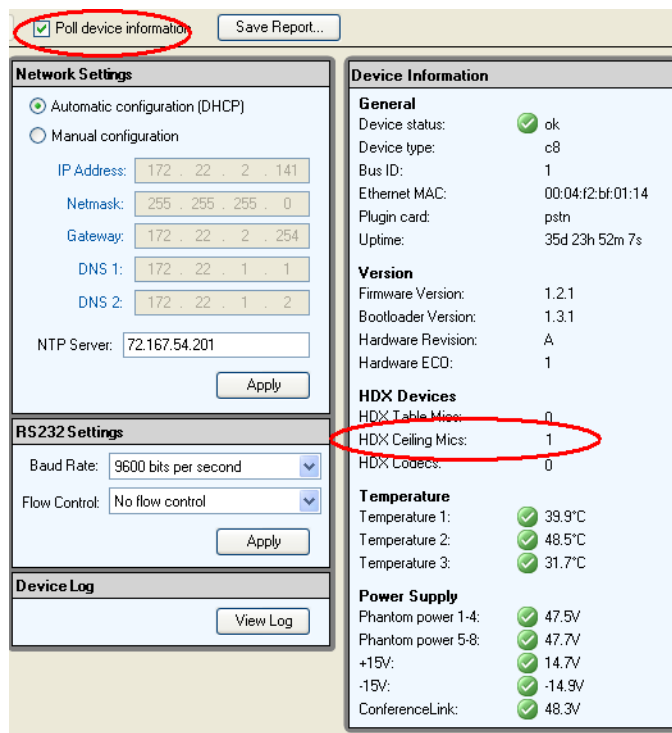

The SoundStructure device's log entries may be checked by clicking the View Log button on the wiring page to see if there were any problems with the firmware updates. If the LED on the HDX microphone lights up solid orange, the log will show a series of attempts to update the firmware in the microphone and provides validation that the microphone has not been able to have its firmware updated. The log entries in this case would look like the following entries that show the firmware on the microphones is trying to be updated repeatedly.

```
Mar  3 15:09:29 soundstructure user.info lcp: sts: conference link mica download event (old f/w 24)
```

```
Mar  3 15:09:32 soundstructure user.info lcp: sts: conference link mica download event (old f/w 24)
```

```
Mar  3 15:09:34 soundstructure user.info lcp: sts: conference link mica download event (old f/w 24)
```

```
Mar  3 15:09:40 soundstructure user.info lcp: sts: conference link mica download event (old f/w 24)
```

```
Mar  3 15:09:43 soundstructure user.info lcp: sts: conference link mica download event (old f/w 24)
```

The log entries for a valid detection of the microphone will look like the entry below for a single HDX microphone that has version 28 firmware.

```
Mar  3 15:02:53 soundstructure user.info lcp: sts: conference link configured
```

```
Mar  3 15:02:53 soundstructure user.info lcp: sts:      [1] SoundStructure
```

```
Mar  3 15:02:53 soundstructure user.info lcp: sts:      [2] HDX Mic (f/w 28)
```

At the end of this step all microphones will have the most recent firmware and are confirmed to operate individually when connected to SoundStructure.

Step 2 – Verify microphones operate when daisy chained

Once all microphones have been tested and had their firmware updated, cascade the microphones on the floor or in the room before installing in their final location (i.e., don't install in the ceiling yet) to check that all microphones are fully operational prior to final installation.

Follow the recommend cable length requirements to ensure your microphone configurations match the following figure. The first microphone may be up to 100ft from the SoundStructure device and subsequent microphones should be separated by no more than 25ft. The total length of the entire chain should be no more than 175ft.

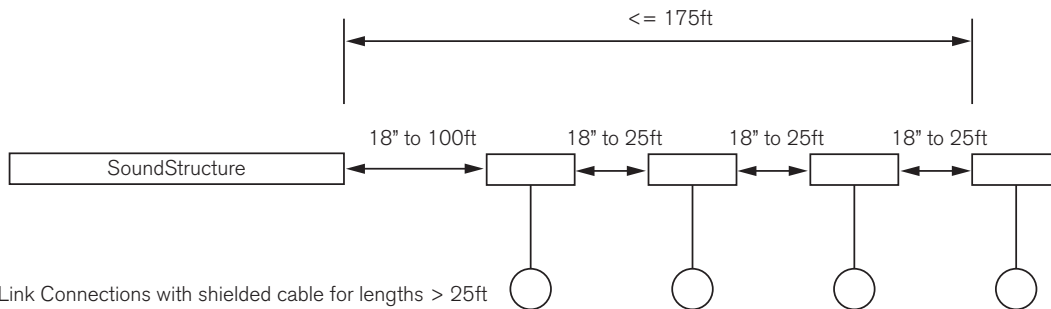

Note: Following the cable length requirements is critical to successfully installing HDX microphones. Cables lengths should be no more than 25ft between microphones.

With all microphones connected you should see that all microphones are detected by the SoundStructure device as shown in the following screen capture. Please note that the Poll Device Information box should be checked to make sure microphones are shown as they are discovered. If the Poll Device Information box is not checked, then the information on the wiring page will only be updated when you navigate to the wiring page from a different page.

In the following figure, two microphones were cascaded together and the resulting two microphones are shown on the Wiring page within SoundStructure Studio.

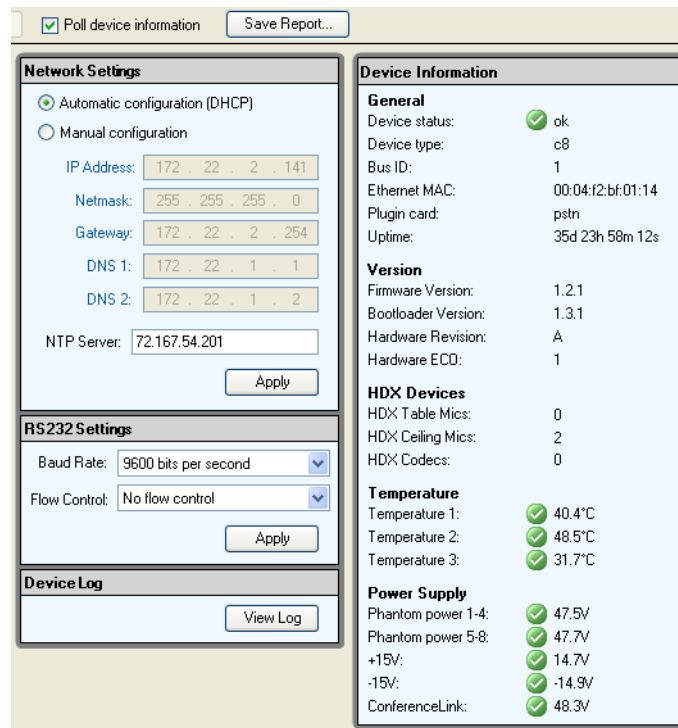

If not all microphones appear on the Device Information tab on the wiring page then the following troubleshooting steps will be required.

1. Make sure the Poll Device Information button is checked.
2. Confirm that the cable lengths meet the requirements and there are only 25ft lengths between microphones.

Do not use a 50ft conference link cable between two microphones.

3. Simplify the system by starting with one microphone and then add the next microphone to see if it is discovered. If the next microphone is not discovered then check the cable between the first and second microphone to make sure it is securely plugged into both microphones and meets the length requirements. If the next microphone is not discovered, replace the cables with a known good cable.
4. If the next microphone is still not detected try changing the orientation of microphone to connect the other microphone port to the cable and see if the microphone can be connected that way. This will tell us whether the cable is the problem or perhaps a port on the microphone.

Note: Do not use the 50ft conference link cable between microphones. The maximum length between microphones is 25ft.

If you have built custom cables please check them carefully to ensure they are built to meet the pin outs of the Conference Link cables. Standard T568A or T568B network pin-outs will not operate. For lengths over 25ft Polycom recommends using shielded Cat 5E cable with the pin-out described in the Cable Pin Out Section.

Step 3 – Check the channels page for valid signals levels

Once all the microphones are all discovered and the microphones have been properly detected, the next step is to ensure all microphones generate signal level. If you are using ceiling microphones, connect the ceiling microphone ball to the ceiling microphone electronics.

Your SoundStructure Studio project should have been designed with the desired number of HDX microphones. You may confirm the number of HDX microphones that are in the project by looking at the wiring page as shown the figure below. In this example two HDX table microphones were designed as part of the project. These microphones are using the processing associated with inputs 3 through 8 on the SoundStructure C8 device.

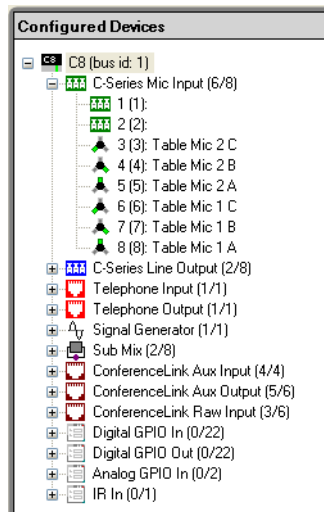

Navigate to the channels page and ensure the meters are on (check the lower right hand corner of the Studio window and right click to enable meters if they aren't already enabled). When you make some noise you should see some signal activity as shown in the figure below.

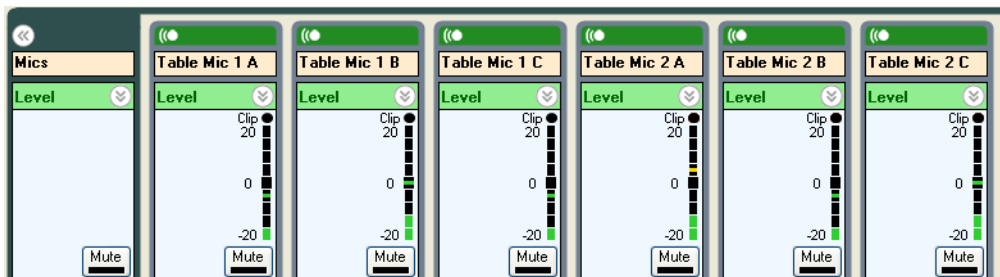

If you do not see signal activity from some microphones:

1. Check that the ceiling microphone ball and connecting cable have been plugged in properly to the ceiling microphone electronics
2. Exchange the ceiling microphone ball and cable from a microphone that is operating with a microphone that is not showing any signal activity to see if the lack of audio follows the microphone ball and cable.
3. If there is still no signal activity from some microphones, use the Edit Channels function on SoundStructure Studio and remove all the HDX microphones in the project and then add the microphones back in. After doing this please save your settings to a preset to ensure that the microphones that were newly added are stored permanently.

At the end of this step all microphones are known to be working and signal activity has been confirmed on the microphones.

Step 4 – Install the microphones in final desired locations

Disconnect the temporary configuration of microphones from the SoundStructure and place the microphones in their final locations. As the microphones are connected, confirm with SoundStructure Studio that the microphones are all detected as described in Step 2.

If different cables are used in the ceiling than were used in Step 2, take care to add microphones one at a time so that any cable issues can be easily identified. If microphones are not discovered in this step then it is a cable issue.

Note: *If different cables are used in the ceiling than used in Step 2 add microphones one by one to make it easy to identify any cable issues.*

At the end of this step all microphone are known to be working in their desired installed positions.

Step 5 – Confirming and adjusting signal levels

With all microphones in their final installed location it is now possible to check that signal levels are still present and there is noloud HVAC noise present on the microphones. Please note there is no analog input gain adjustment on SoundStructure for the digital microphones because the audio is digitized at the microphone and transmitted digitally to the SoundStructure device.

You may want to add up to 6dB of gain to the input fader control when using ceiling microphones to get the signal level to the desired 0dBu level. Additional input fader gain is neither required nor recommended because you don't want too much gain on the microphones in case participants are standing close to microphones.

You are looking to achieve a signal level for a talker into the microphone that looks similar the figure below. The average signal level should hit the 0dB mark regularly and the peak bar should be above the 0 mark.



The HDX microphones are directional, so you will only see this level on a particular input when a local talker is speaking into a particular microphone element.

A much higher signal level into a microphone may be an indication that there is HVAC blowing directly on a microphone. To fix this issue you may need to lower or raise the microphone to get it out of the HVAC air flow.

For situations where the HVAC noise can not be removed by changing the length of the cable between the microphone ball and the microphone electronics, then you may be able to add a high pass filter to the input at 250Hz to try to remove much of the noise.

At the end of this step you have microphones with proper level and operation in their final installed locations.

Which HDX Microphone is Which?

When HDX microphones are connected in the recommended method to the right rear Conference Link port for SoundStructure they will be enumerated as follows: Microphone 1 will be the microphone that is closest to the SoundStructure and Microphone 4 will be the microphone that farthest from the SoundStructure device as show in the following figure.

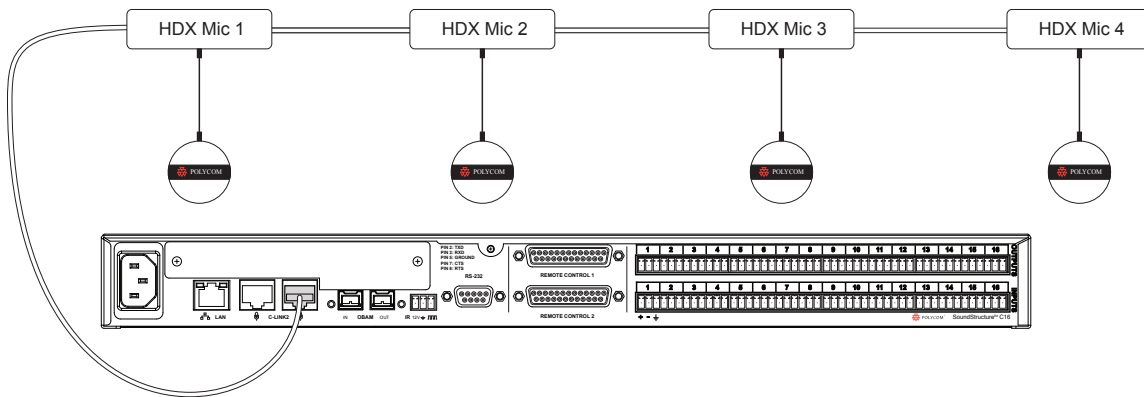

In SoundStructure Studio these microphones correspond to the Wiring page as shown in the following figure.

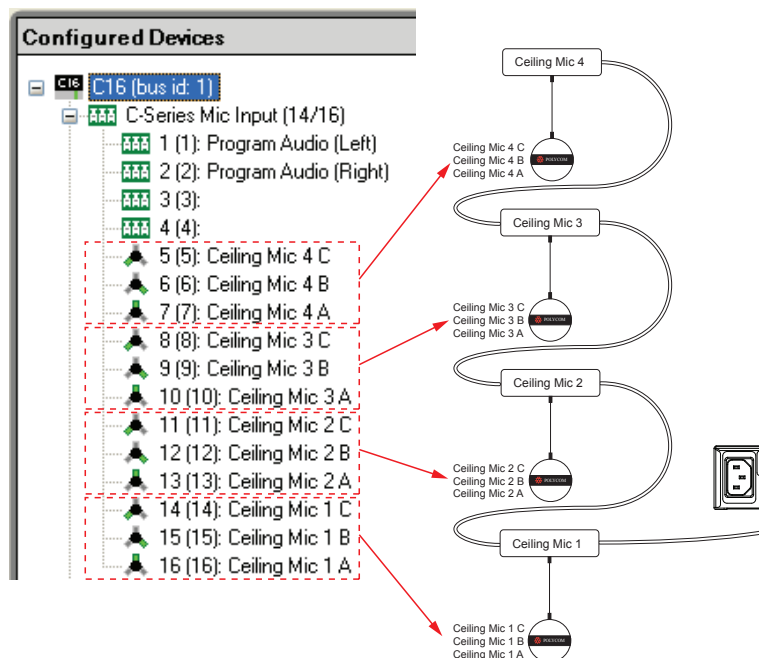

The ordering of the microphones is important in some application such as room combining where you want to make sure you have the proper microphones going to the proper remote sites.

If the HDX microphones are plugged into the left rear Conference link port, the microphone numbering is the reverse of the when the microphones are plugged into the right rear Conference link port. This means the first microphone would be the microphone that is farthest from the SoundStructure device and the last microphone would be the microphone that is closest to the SoundStructure device.

Note: Polycom recommends plugging the HDX microphones in the right rear Conference Link port on SoundStructure devices.

SoundStructure and HDX and HDX Microphones

When a SoundStructure device, HDX video codec, and HDX microphones are used together, it is recommended that the system be connected as shown in the following figure with the HDX microphones connected to the right rear Conference link port on SoundStructure and the HDX codec connected to the left rear Conference link port on SoundStructure.

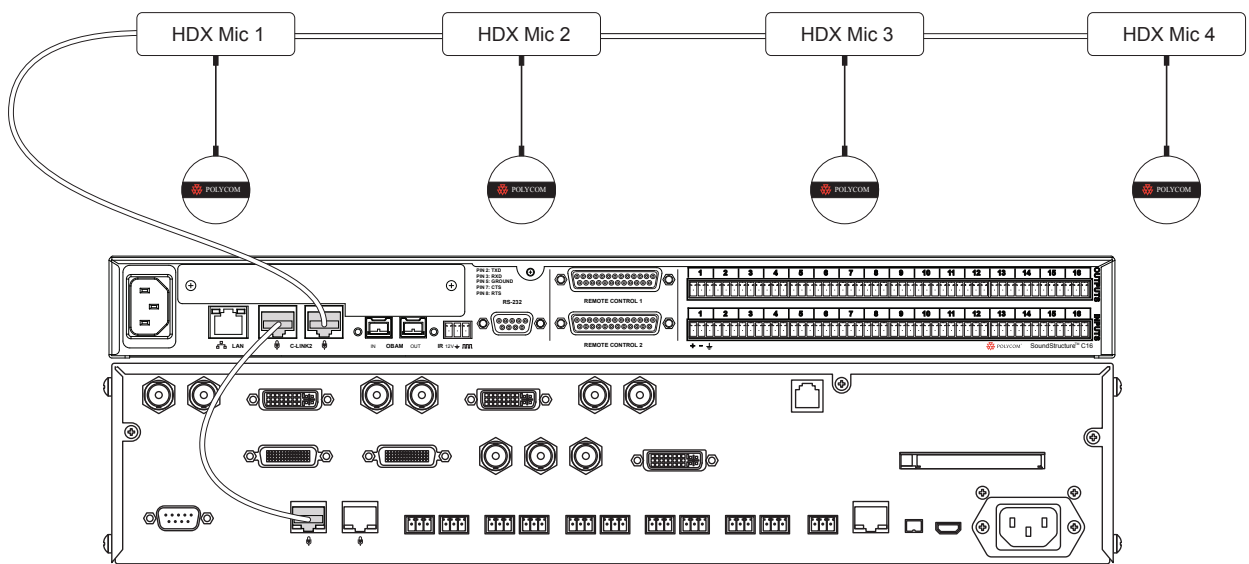

In the HDX video codec, it is recommended to enable the "Live Music Mode" on the HDX under the Audio settings to disable the far-end echo exterminator and keyboard tapping detector. This will simplify the configuration and troubleshooting of the end-to-end audio system. In some versions of HDX firmware, you may have to unplug the Conference link connection between the SoundStructure from the HDX to see the option for "Live Music Mode".

All the Conference link cables shown in this diagram are Conference link cross over cables. Please note that whenever two Conference link devices are connected together, the connection must result in a single cross over. This can be accomplished with the appropriate Conference link RJ45 cable, Conference link microphone cable, or by using a combination of adapters and cables such that ONE effective crossover is included in each cable run between devices.

Maximum number of HDX microphones that can be used

When a SoundStructure device is used with HDX video codecs, the maximum number of microphones that may be connected to the SoundStructure device that is connected to the HDX codec via Conference Link is shown in the table below.

Maximum Number of HDX Microphone Supported			
HDX Firmware	HDX7000 +C-series	HDX8000 +C-series	HDX9000 +C-series
2.0.3	2	3	4
2.5.0.1	2	4	4

A SoundStructure device supports up to 4 HDX microphones depending on the number of analog inputs. Each HDX microphone requires the processing of 3 analog inputs.

If additional HDX microphones are needed for an installation, see the next section on how multiple SoundStructure devices may be linked together to add more HDX microphones to an installation regardless of which, if any, video codec is used.

HDX 8000 and SoundStructure

When using the HDX8000 family of video codecs, the same cabling topology described above is recommended. Due to the Walta connector on the Polycom HDX8000 video codec, different cabling is required to connect the HDX8000 to the SoundStructure device as shown in the following figure. Note that the cable adapter 2457-25646-001 has a Walta male connector on one end (the HDX codec end) and an RJ45 female socket on the other end (the SoundStructure end). This makes it possible to use the 18" Conference link cross-over cable that is supplied with SoundStructure to go from SoundStructure to the dongle and from the dongle to the HDX8000 codec.

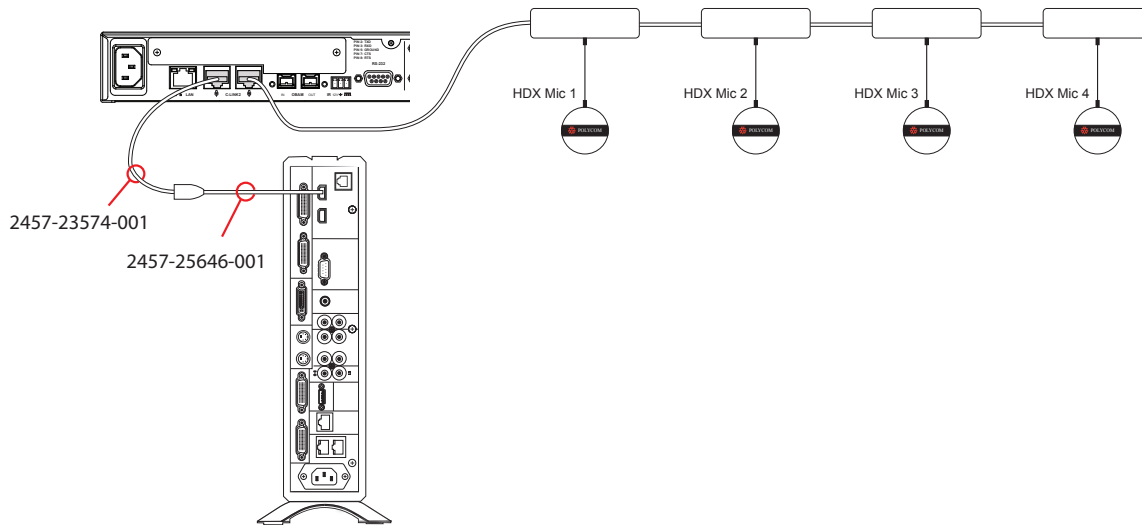

The 2457-25646-001 cable converter may also be used to connect HDX table microphones to SoundStructure as shown in the following figure. The Conference Link crossover cable from SoundStructure to the cable converter may be custom-built to support the required length and should be terminated with RJ45 connectors on both ends as shown in the Cable Pin Out section below.

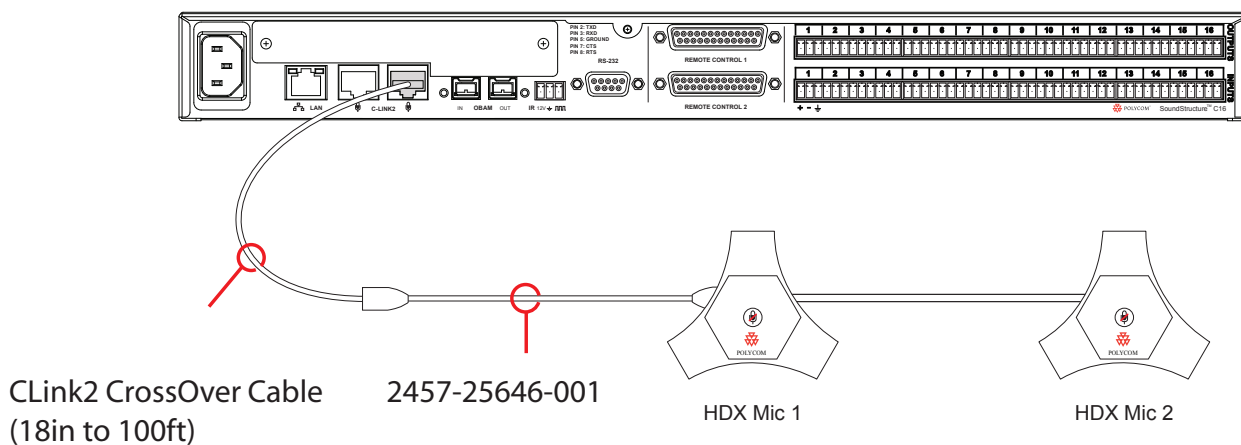

Multiple SoundStructure Units and HDX Microphones

Since each SoundStructure device can support up to four HDX digital microphones, using more than four HDX microphones requires using more than one SoundStructure device and linking the SoundStructure devices via the OBAM interface.

As example, consider the design of a system with 6 HDX microphones and an HDX video codec. SoundStructure Studio will create a design that would be connected as shown in the following figure. The first four HDX microphones will be connected to the C16 and the remaining two HDX microphones would be connected to the SoundStructure C8. In addition the Polycom HDX would be connected to the first SoundStructure C16 in this example.

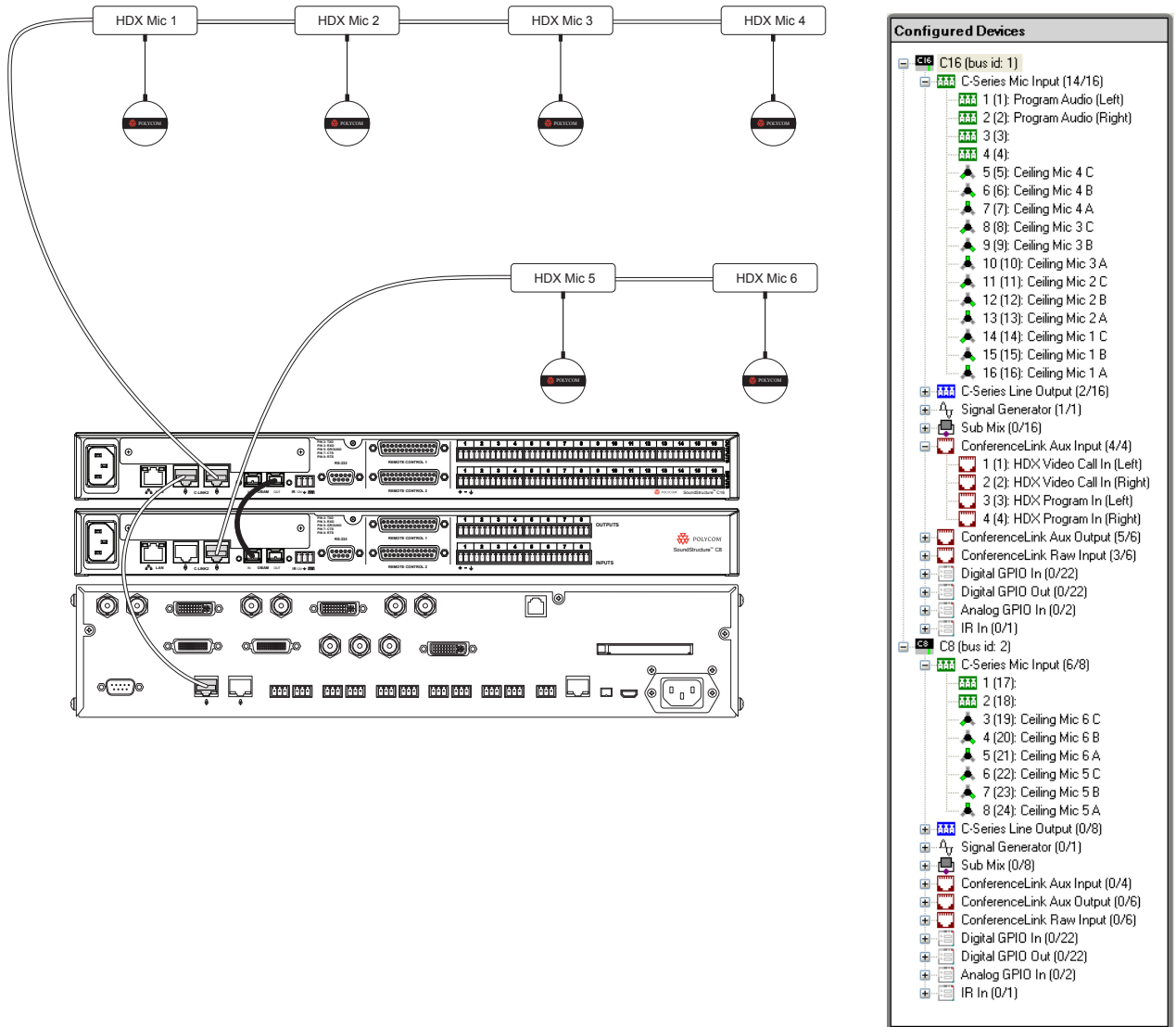

The SoundStructure Studio wiring page shown below shows where the HDX microphones should be connected and to which SoundStructure device they should be connected. The ConferenceLink Aux Input area on the wiring page shows that the HDX video codec, in this example, is connected to the SoundStructure C16.

If a second HDX video codec were added to the system, the ConferenceLink Aux Input on the SoundStructure C8 would have been defined for the second video codec. One HDX codec may be attached via Conference Link to each SoundStructure device that is linked over OBAM.

The HDX codec will only show the number of microphones that are connected to the SoundStructure on the Conference Link chain as the HDX codec. In this example, the HDX codec will discover a SoundStructure C16 and four HDX microphones even though there are six HDX microphones that are used in the system. Although the HDX microphones that are connected to other SoundStructure devices via OBAM are not counted by the HDX codec when it counts how many microphones it has found, those microphones are fully utilized and audio from all microphones is sent to the remote participants via the HDX video codec.

The HDX microphones are shown in SoundStructure Studio as a sequential list of microphones based on the OBAM bus ID. For example, the mics connected to the first SoundStructure device (the one with only an OBAM out connection) will be the microphones 1 – N (in the example above, microphones 1 – 4), the HDX microphones on the next SoundStructure device (connected to the OBAM out of the first SoundStructure device) will be the microphones N+ 1 to M (in the example above, microphones 5 and 6), and so forth through the OBAM link of multiple SoundStructure devices.

As with single SoundStructure device systems described previously, we recommend you follow the best practices for using multiple HDX microphones with the SoundStructure devices.

These steps are summarized here (see the previous section for detailed steps).

Step 1: Connect the microphones one at a time to the first device (the C16 in this example) and ensure the microphones are discovered and have their firmware updated. If there is an HDX in connected to the SoundStructure devices over Conference Link, disconnect it prior to plugging the HDX microphone into SoundStructure.

By connecting the microphones to the first device, the log entries for the first system can be checked to see if there were any problems with the firmware updates. It would be helpful to review the log if, for example, the microphone LEDs light up solid orange after being connected to a SoundStructure device. When multiple SoundStructure devices are linked together over OBAM, the overall log will only show the microphone firmware updates of microphones plugged into the first SoundStructure device (the device that only has an OBAM out connection)

Step 2: Daisy chain the microphones before final installation and ensure all microphones are discovered. When multiple SoundStructure devices are used, create the chain of microphones for the each SoundStructure and ensure the microphones are all discovered by adding the microphones one at a time while watching the Device Information section on the wiring page for the particular SoundStructure device. By clicking on different devices on the wiring page the Device Information area will reflect the values for that particular SoundStructure device. Remember to enable Poll Device Information to see microphones as they are found on conference link.

Step 3: Check the wiring page to ensure that all microphones are generating valid signal activity. If microphones are discovered (as seen the Device Information area on the wiring page) but there is no signal activity from the microphone then use the Edit Channels function on SoundStructure Studio and delete all the HDX microphones in the project and then add the microphones back in. After doing this please save your settings to a preset to ensure that the microphones that were newly added are stored permanently. Deleting and re-adding the microphones will reset the mic_source_index parameter that determines which time slots the microphone audio is taken from the conference link interface.

Step 4: Install the microphones in their final locations

Step 5: Confirm that there is signal activity and adjust the input fader control if necessary.

Advanced Applications with HDX Microphones

Using Fewer than three microphone elements

Each HDX microphone has three microphone elements and requires the processing of three analog inputs within SoundStructure. If a particular microphone element is not required, it is possible to remove one or more microphone elements from HDX microphones within SoundStructure Studio so that fewer than three microphone elements are processed by SoundStructure.

Note: *If one or more HDX microphone elements are removed from a design, the audio from those microphone elements is no longer available to the SoundStructure device. Removing a microphone element is equivalent to “unplugging” the microphone element.*

For example, consider a SoundStructure design that has two HDX microphones connected to a SoundStructure C8 device. In this case, six of the analog inputs are used to process all the audio channels of the HDX microphones as shown in the wiring page below, leaving only two analog inputs available.

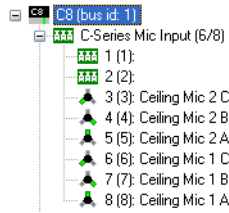

Using the Edit Channels control it is possible to remove one or more of the microphone elements to make room to add a third HDX microphone. Within the Edit Channels dialog, select the microphone element to remove (refer to the microphone element orientation and labeling described at the beginning of this document) and select Remove.

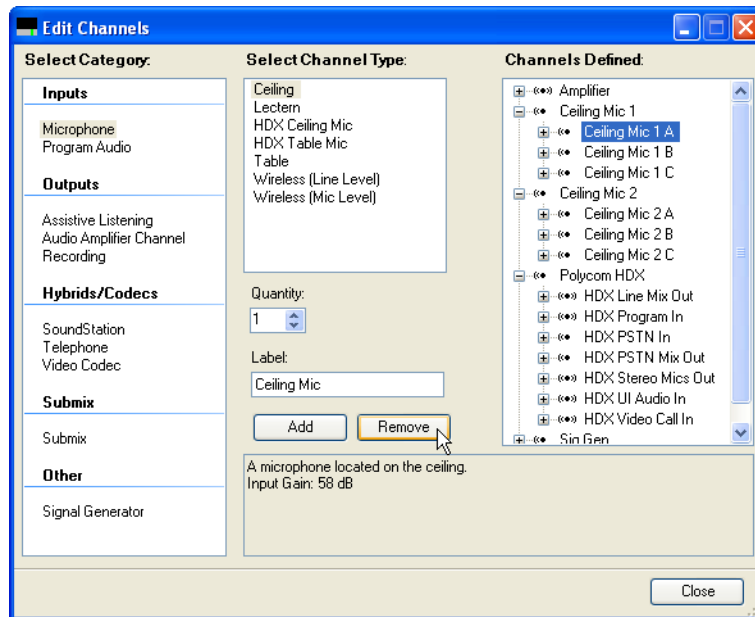

Once the element has been removed, the wiring page is updated to show five HDX microphone elements as shown in the following figure, reflecting the fact that Ceiling Mic 1 A has been removed, or 'unplugged', from the system.

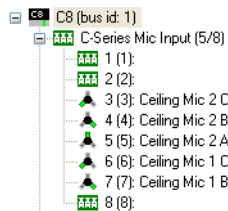

A third HDX microphone may now be added using the Edit Channels control by selecting the microphone type and selecting Add.

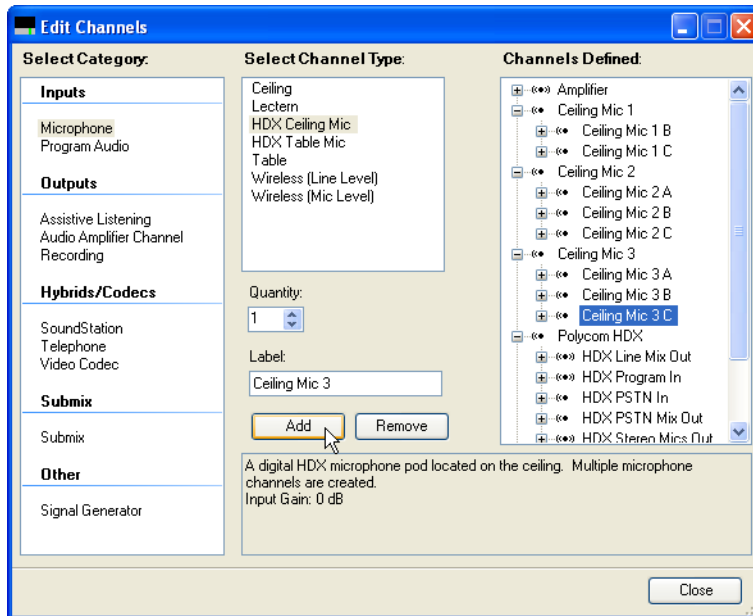

After the microphone has been added, the wiring page shows the third HDX microphone as shown in the following figure with all eight inputs assigned to HDX microphones. In this example a SoundStructure C8 can be used to process 2 and 2/3 HDX microphones.

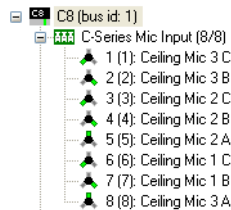

Keep in mind that once the microphone element is removed, the microphone is not part of the system. In this example Ceiling Mic 1 A has been removed and no audio from that microphone element is available within the SoundStructure device.

Switching between Analog or Digital microphone inputs

As described previously each HDX microphone requires the processing of three analog inputs, however we know that the HDX microphones are not physically plugged into the terminal block connectors – they are simply using the processing associated with that physical input. So what happens with any analog inputs that are connected to the terminal block connectors that are assigned to the HDX microphone elements, and can those analog input signals be used?

The answer is that the analog signal inputs can be used, but not at the same time as the HDX digital microphone elements. This means that it is possible to use the inputs of SoundStructure devices in different ways depending upon how the device is configured.

The following figure shows that for each input on the SoundStructure both the analog input and digital input is available. There is a switch that selects which input signal is used for processing and the state of that switch is controlled by the API command mic_source_type.

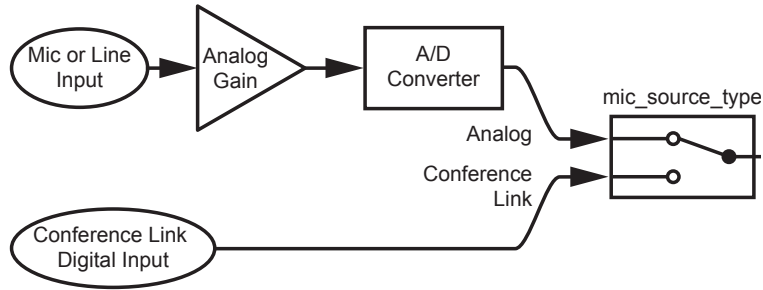

By using the mic_source_type command, it is possible to switch an input that is assigned to an HDX microphone and use the corresponding analog input instead. Please note that both signals can not be used – only the digital signal or the analog signal may be used.

Consider the design below that shows 2 HDX microphones and stereo program audio connected to the SoundStructure device.

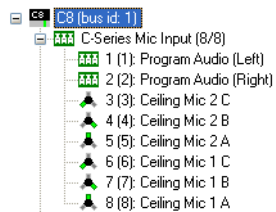

In this example we will take the analog inputs associated with Ceiling Mic 2 A and Ceiling Mic 2 B and select the associated physical analog inputs by sending the SoundStructure the commands:

```
set mic_source_type "Ceiling Mic 2 C" analog
```

```
set mic_source_type "Ceiling Mic 2 B" analog
```

The resulting wiring page now looks like the figure below, with the graphic associated with inputs 3 and 4 changed to terminal blocks to reflect that the analog input is used rather than the digital input from the HDX ceiling microphones.

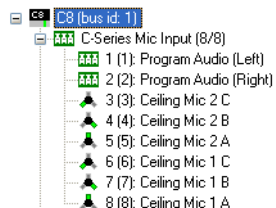

To select the digital microphone element inputs again, use the commands:

```
set mic_source_type "Ceiling Mic 2 C" clink_mic
```

```
set mic_source_type "Ceiling Mic 2 B" clink_mic
```

When using the analog inputs, please note that there are other settings in your project that will likely need to be changed because you may be using the analog inputs in different ways from the digital inputs, meaning that matrix routings, input processing selections, analog input gains, phantom power settings, and other settings may need to change when switching the mic_source_type. For this reason it is recommended that partial presets be created to manage the changes required when switching between the analog inputs and the digital inputs.

Cable Summary

[Cables available on the Polycom Price list](#)

Part Number	Length	Connector 1	Connector 2
2457-25646-001	18 inches	Walta male	RJ45 female
2457-23716-001	12 inches	Walta female	RJ45 male
2457-23574-001	18 inches	RJ45 male	RJ45 male
2457-24009-001	25 feet	RJ45	RJ45
2457-24008-001	50 feet	RJ45	RJ45

Custom cables

Custom HDX microphone cables can be manufactured using RJ45 connectors and Cat5 or CAT5e cables. For lengths greater than 25ft it is recommended that shielded CAT5e cables be used.

To build a custom cable follow the pin outs in the following diagrams.

Unshielded Conference Link Cross over cable

The diagram below shows the typical cross over cable for Conference link. Notice that pins 1 and 2 are mapped to pin 5 and 6 at the other end of the connector. This cable style is appropriate for lengths up to 25ft.

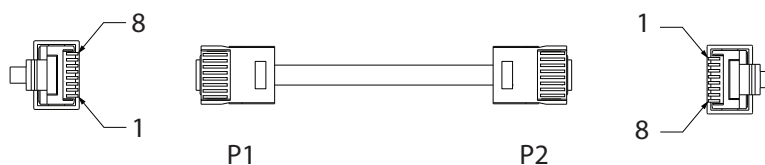

COLOR	AWG	P1		P2
WHITE/GREEN	24	1		5
GREEN	24	2		6
WHITE/BLUE	24	3		3
BLUE	24	4		4
WHITE/ORANGE	24	5		1
ORANGE	24	6		2
WHITE/BROWN	24	7		7
BROWN	24	8		8

Shielded Conference link Cross over cable

The diagram below shows the typical shielded cross over cable for Conference Link. Notice that pins 1 and 2 are mapped to pin 5 and 6 at the other end of the connector. This cable style is appropriate for lengths longer than 25ft.

In the wiring below notice that the pin 4 wire is not used and the shield is connected to pin 3.

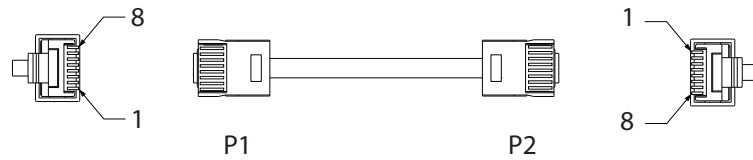

COLOR	AWG	P1		P2
WHITE/GREEN	24	1		5
GREEN	24	2		6
WHITE/ORANGE	24	5		1
ORANGE	24	6		2
WHITE/BROWN	24	7		7
BROWN	24	8		8
DRAIN WIRE	24	3		3
SHIELD		SHELL		SHELL

If you have difficulty tying the shield train to pin 3 of the RJ45, try connecting the blue/white wire to go from pin 3 to pin 3 and then tie the shield drain wire to the metal case of the shielded RJ45.

Also ensure you are using the right type of RJ45 connectors: piercing for stranded-core cable and tulip for solid-core cable. The "universal" connector types are not always reliable.